



nickelodeon

TEENAGE MUTANT NINJA TURTLES



Ages
6+
197 pcs.



79121



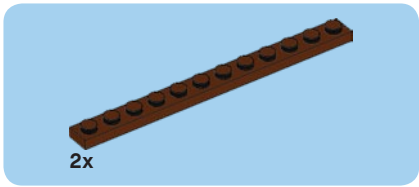

1

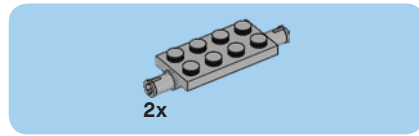
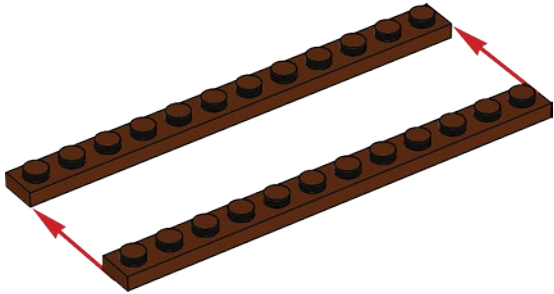

2

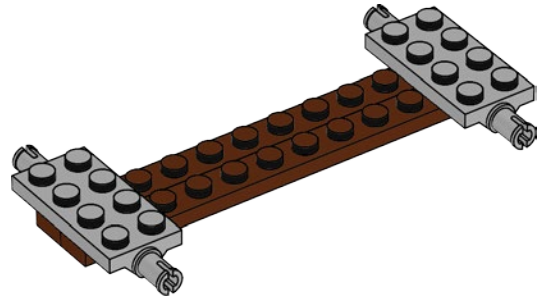

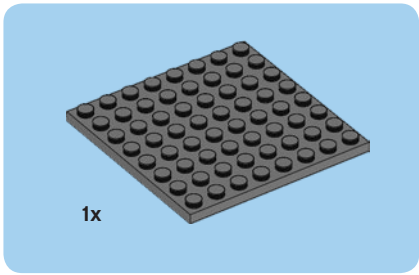

3

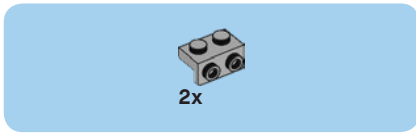
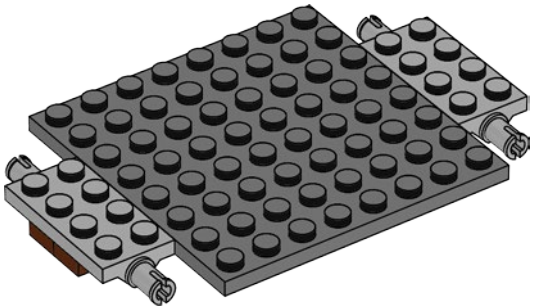

4

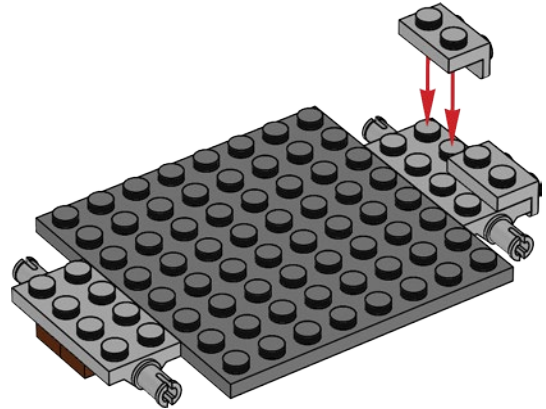

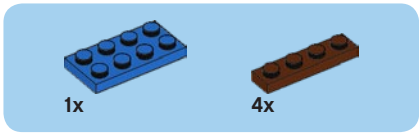

5

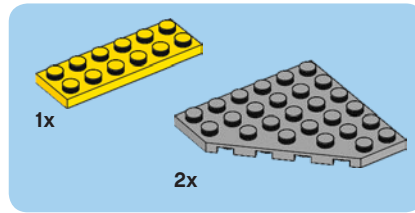
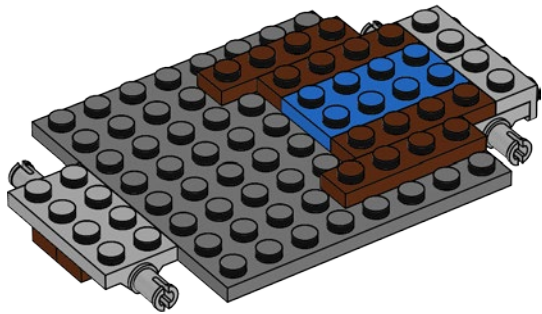

6

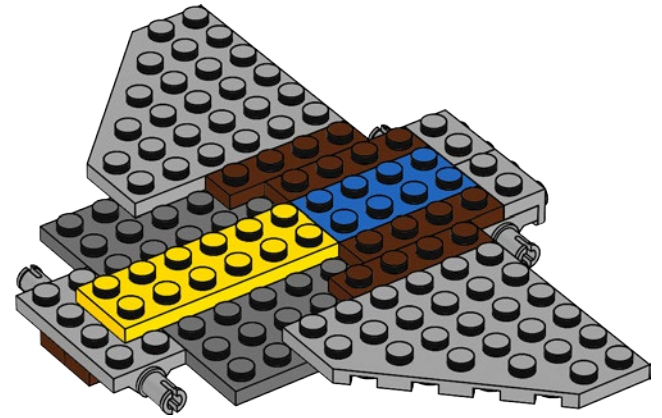



7

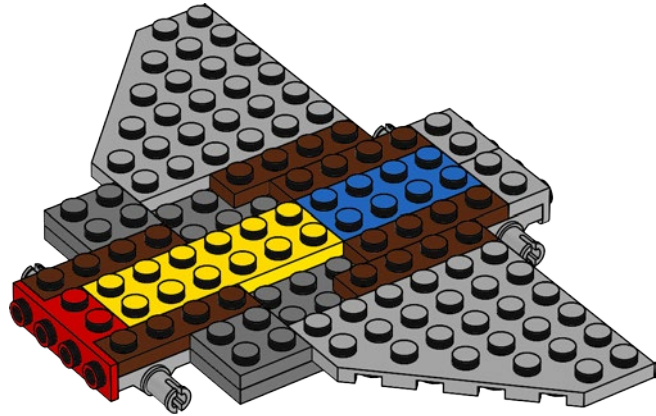

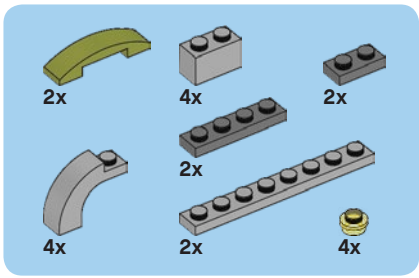

8

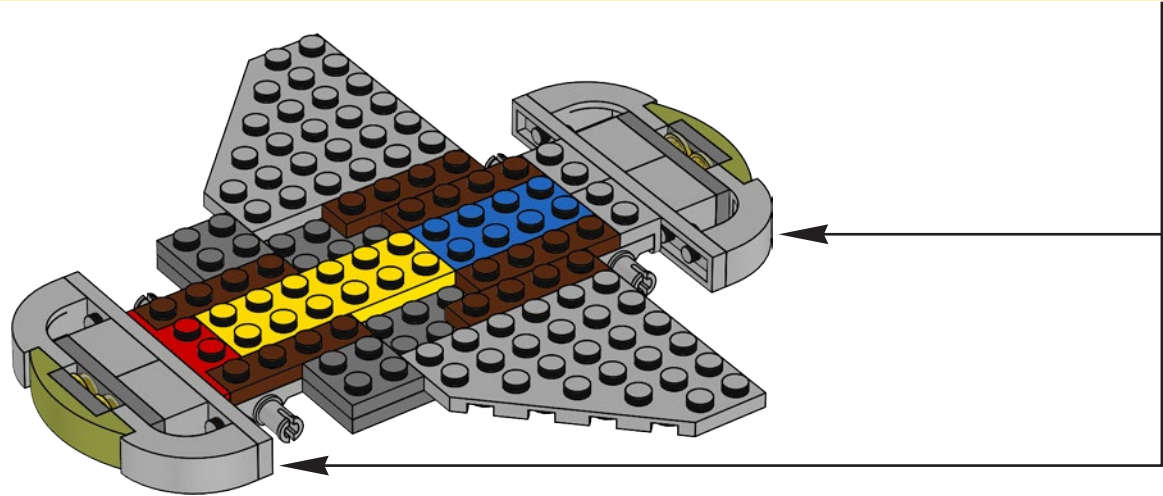
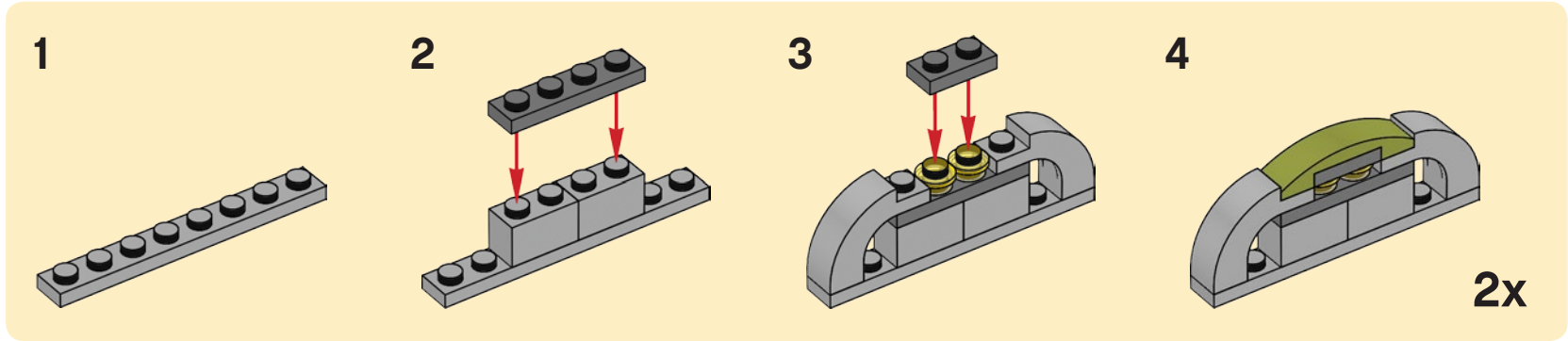

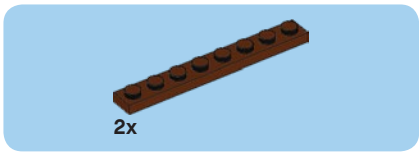

9

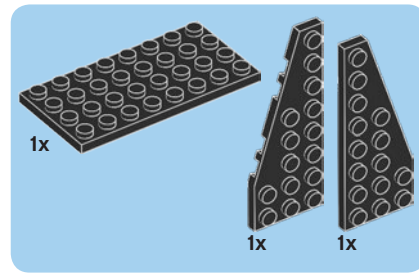

10

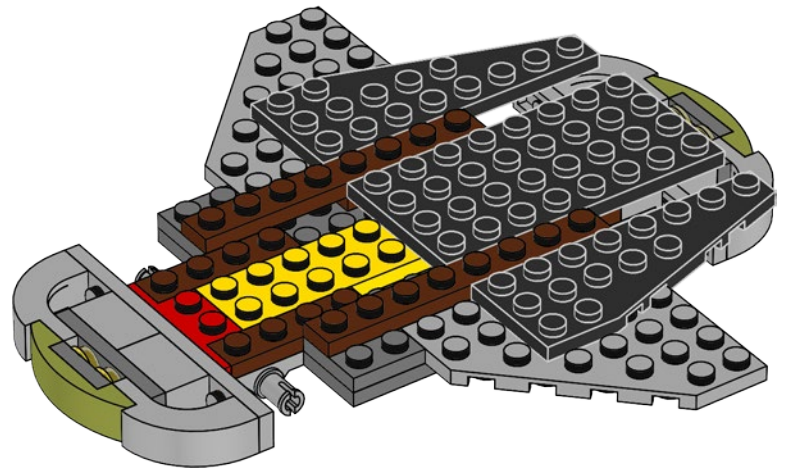
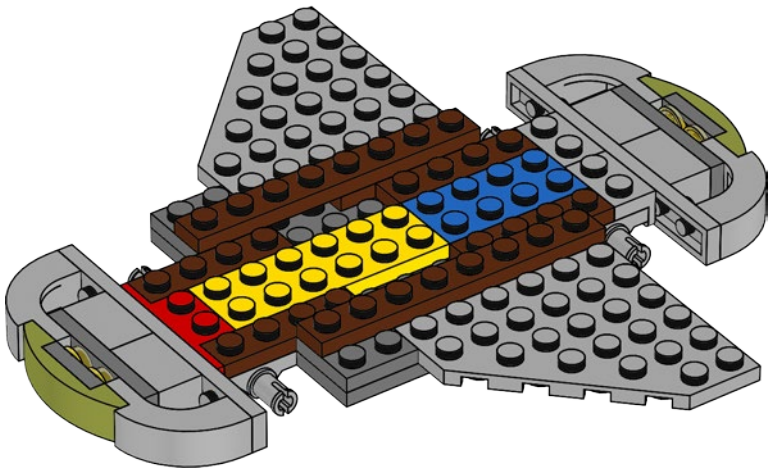

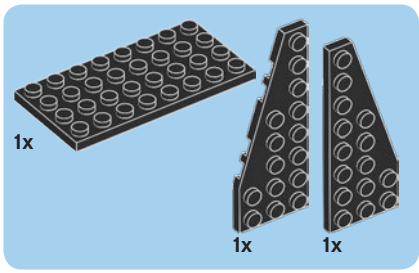

11

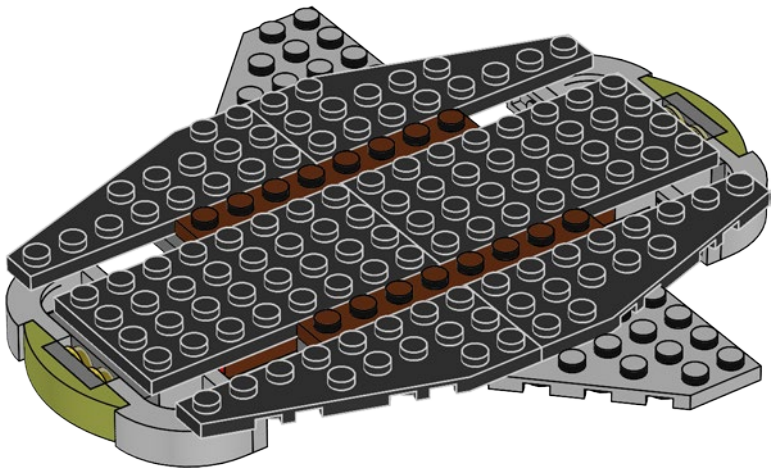

12

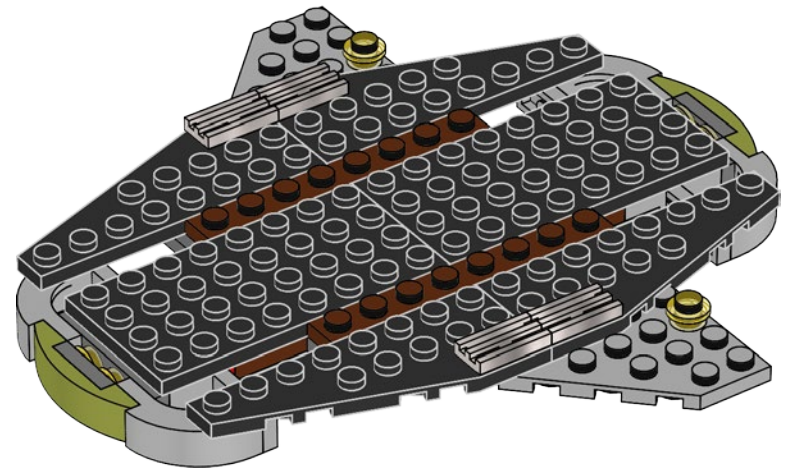

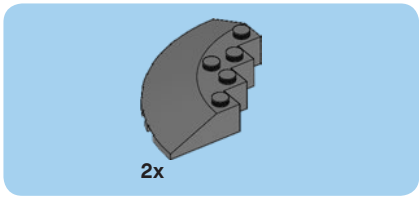

13

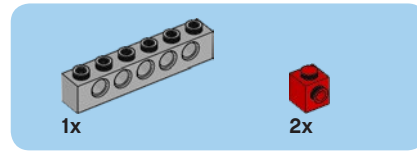
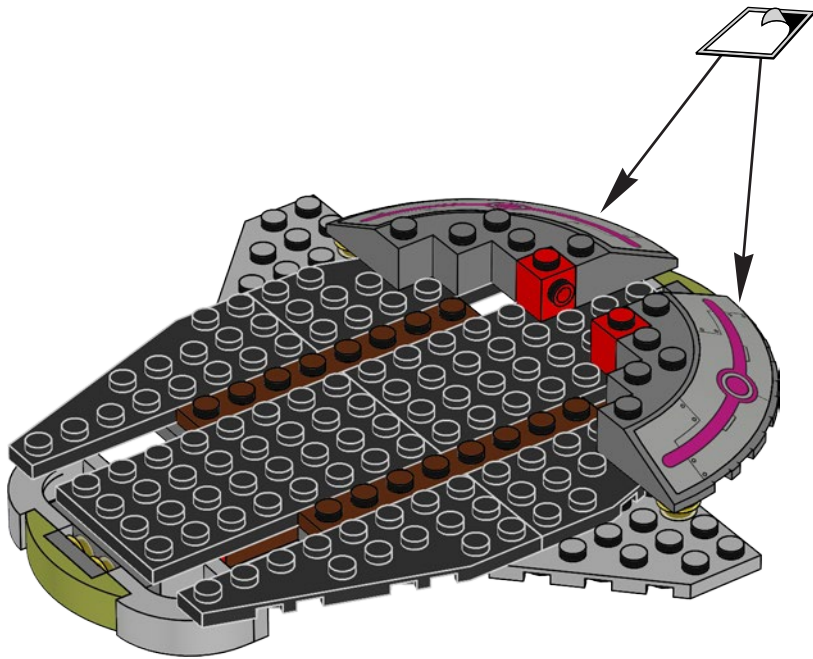

14

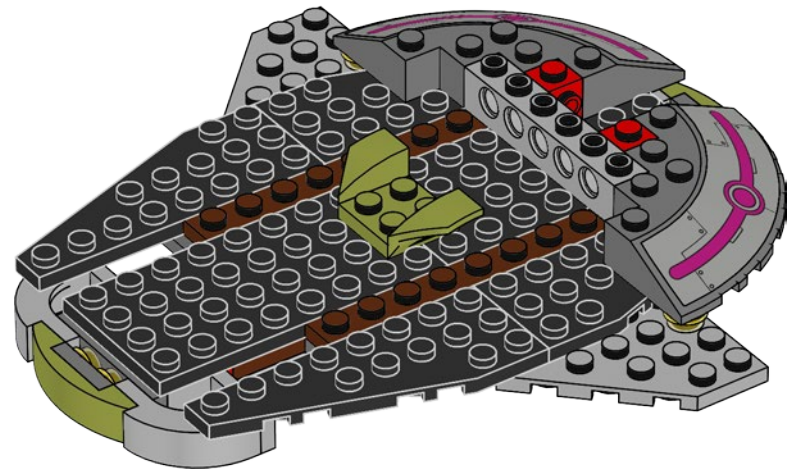

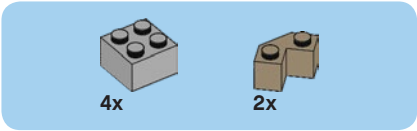

15

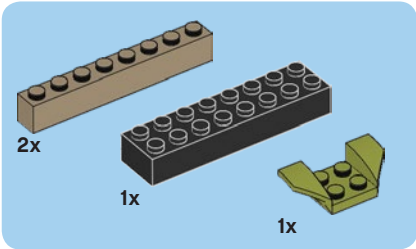
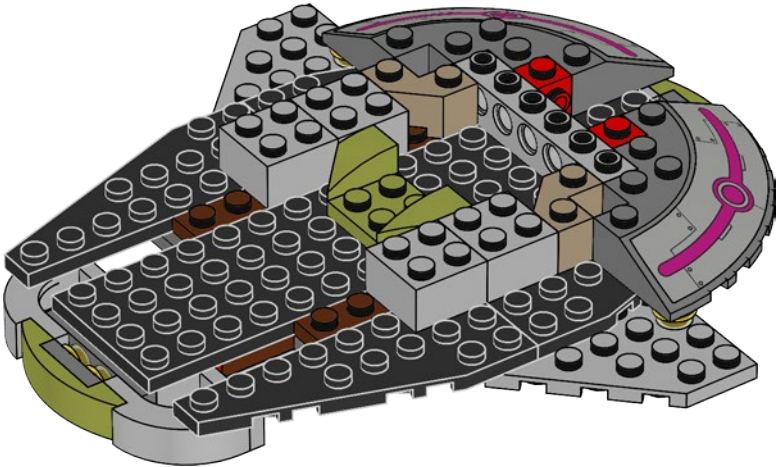

16

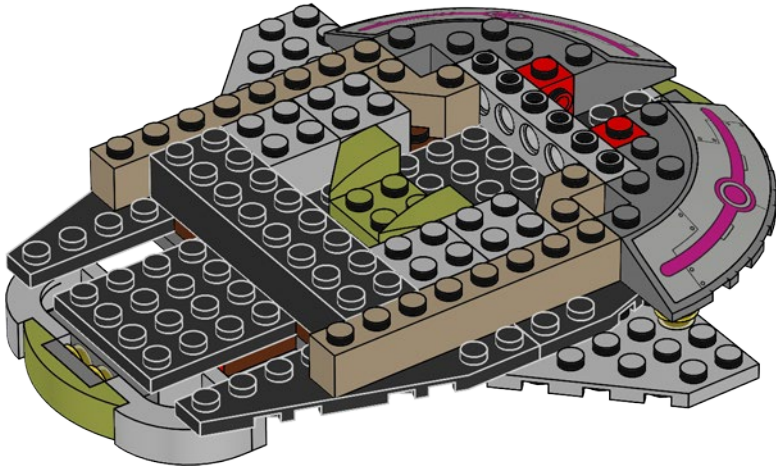



2x



2x

17

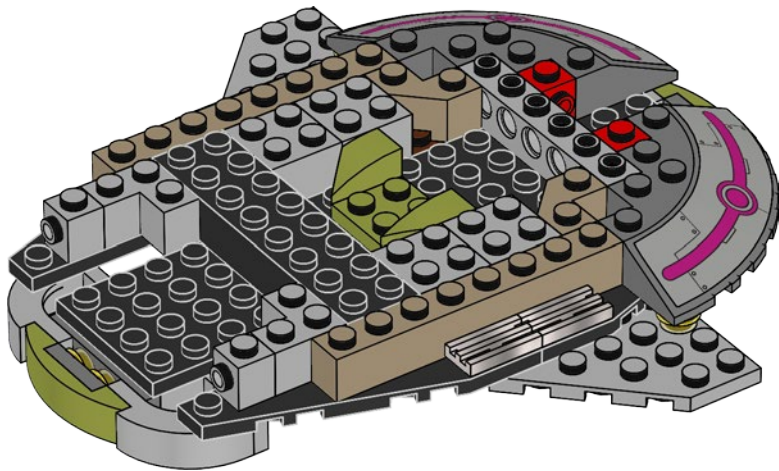

1x

18

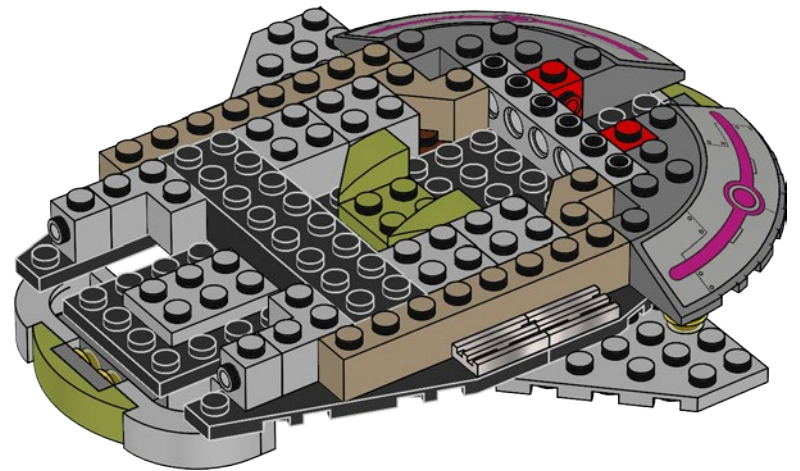



2x



1x

19

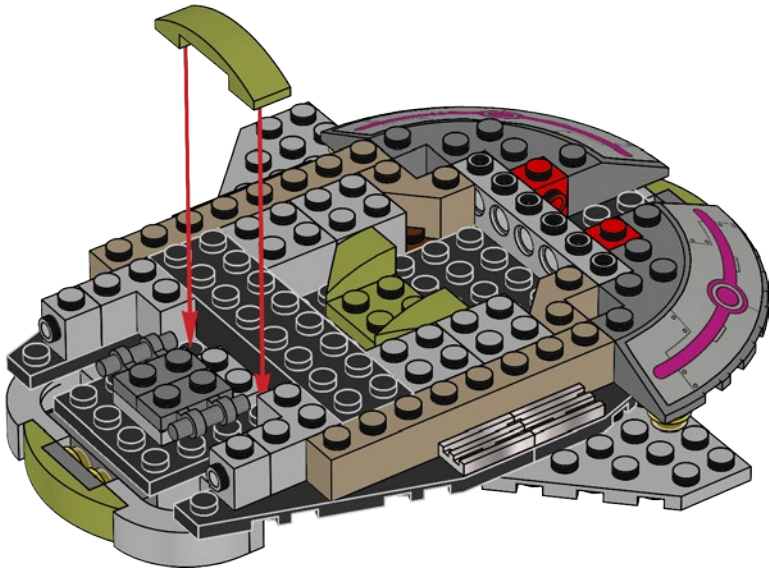

1x



1x

20

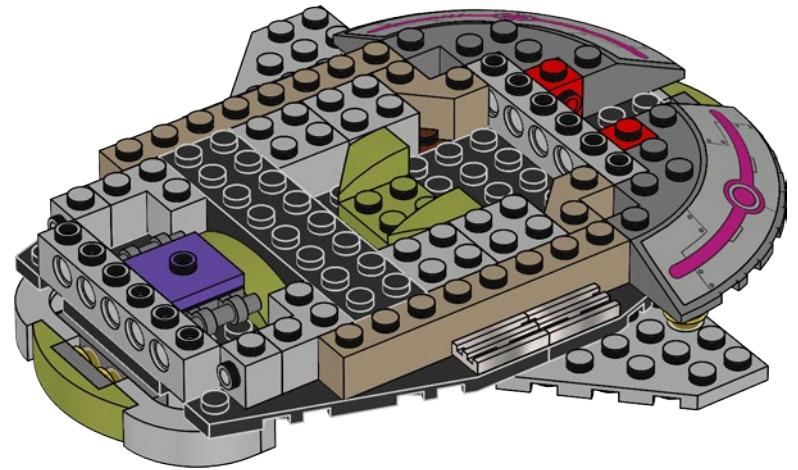



2x

21

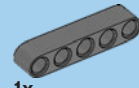
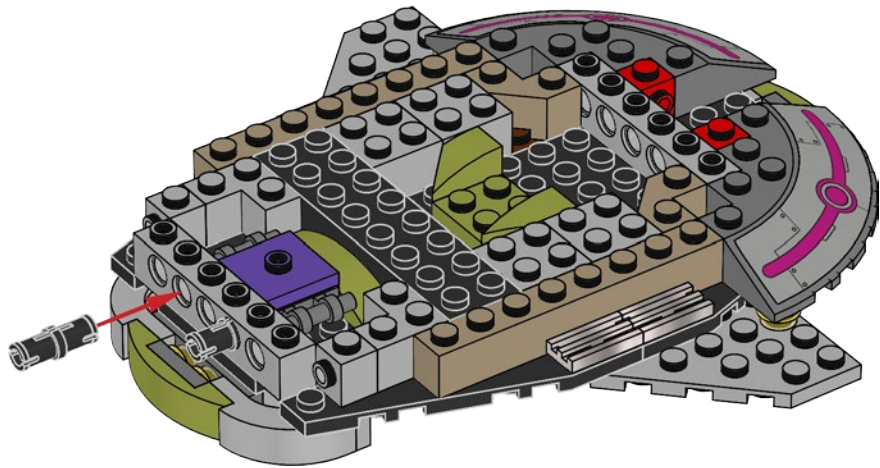

1x

22

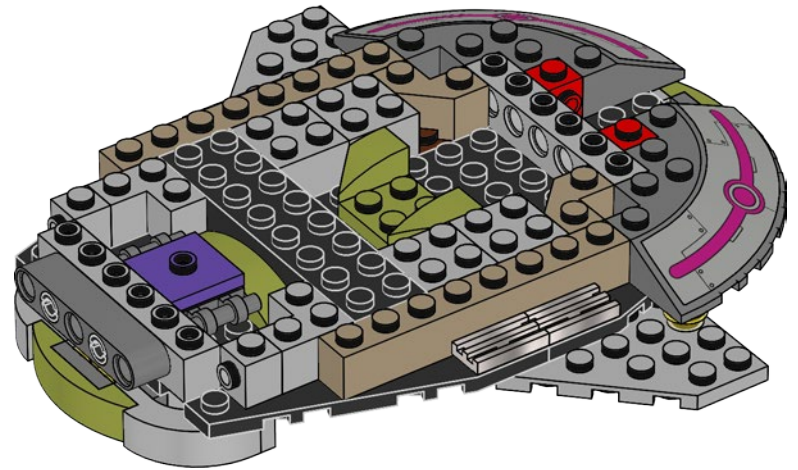



1x



1x

23

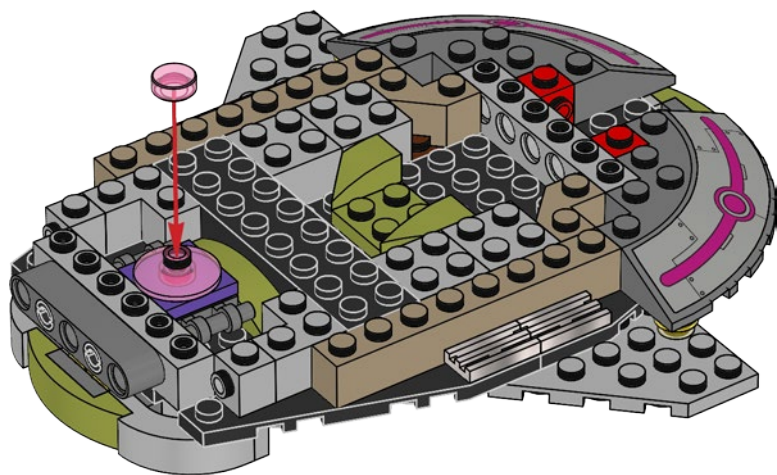

2x



1x



1x

24

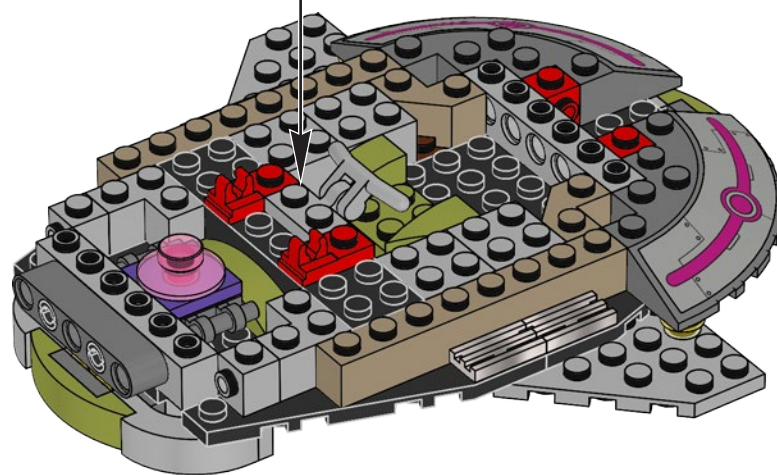
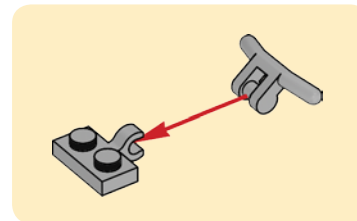

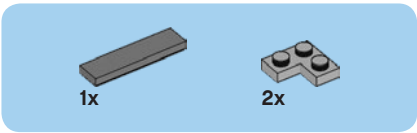

25

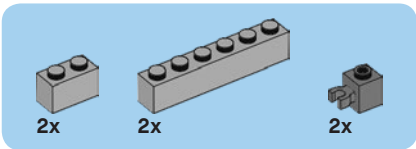
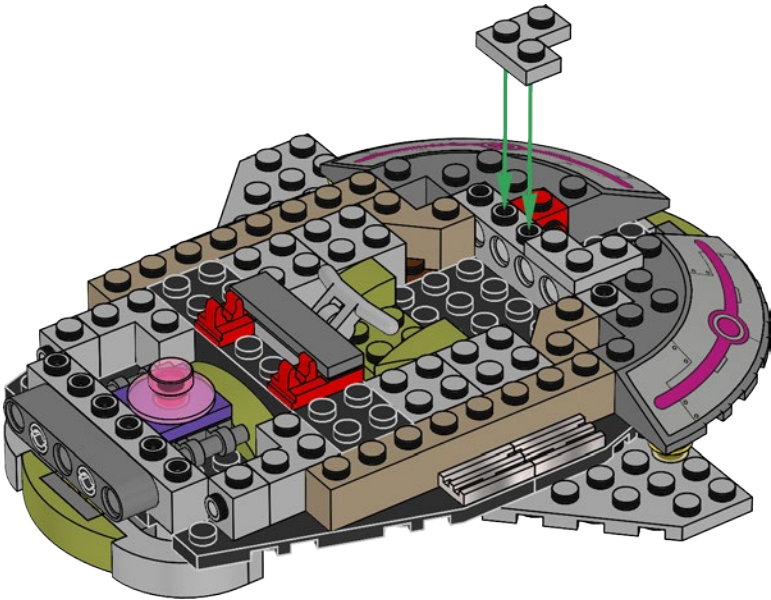

26

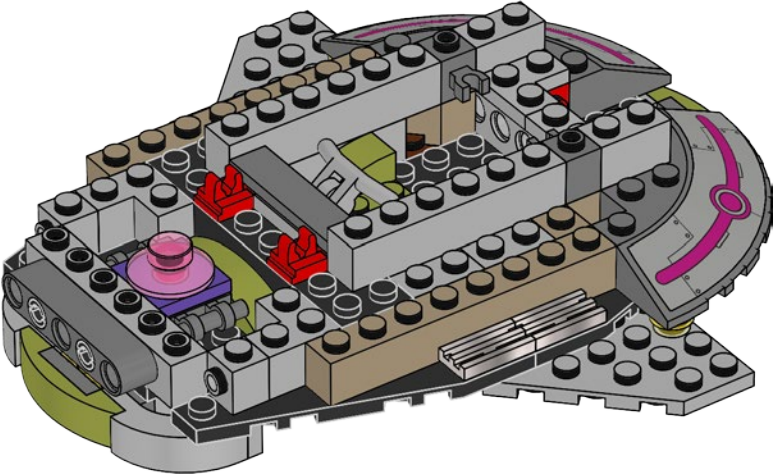

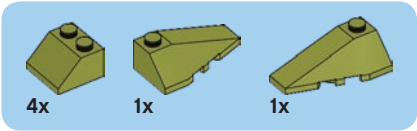

27

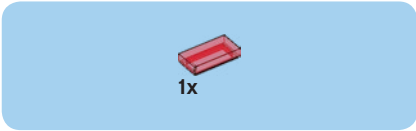
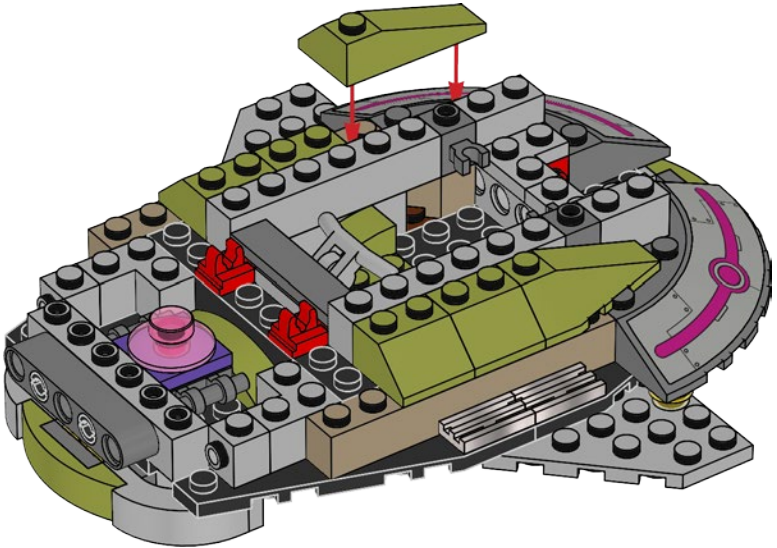

28

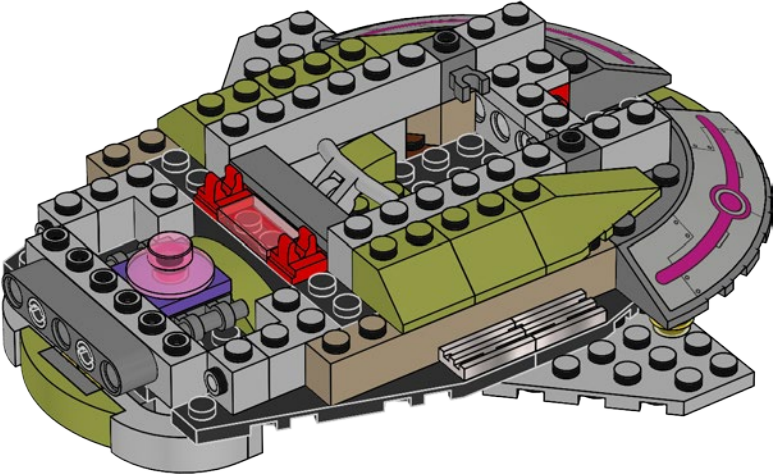



2x

29

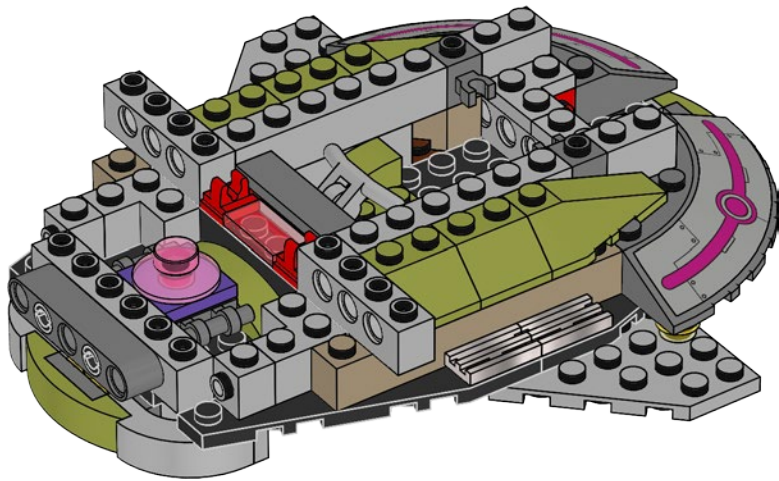

2x

30

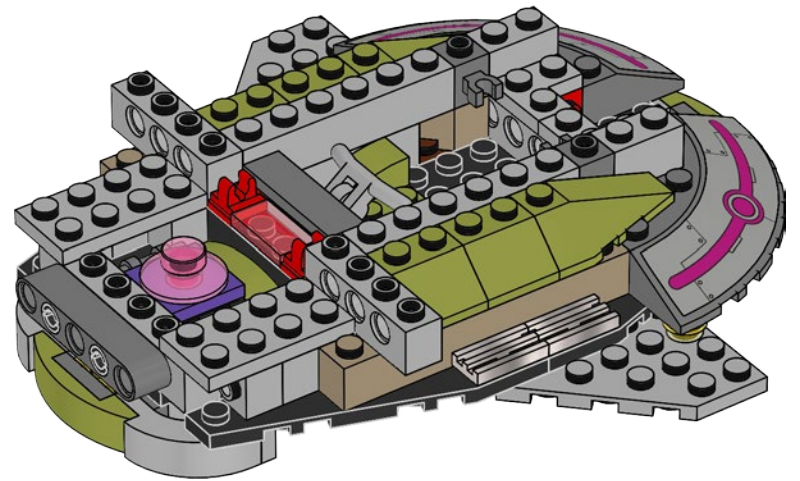

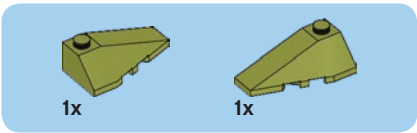

31

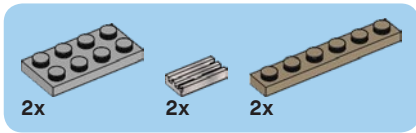
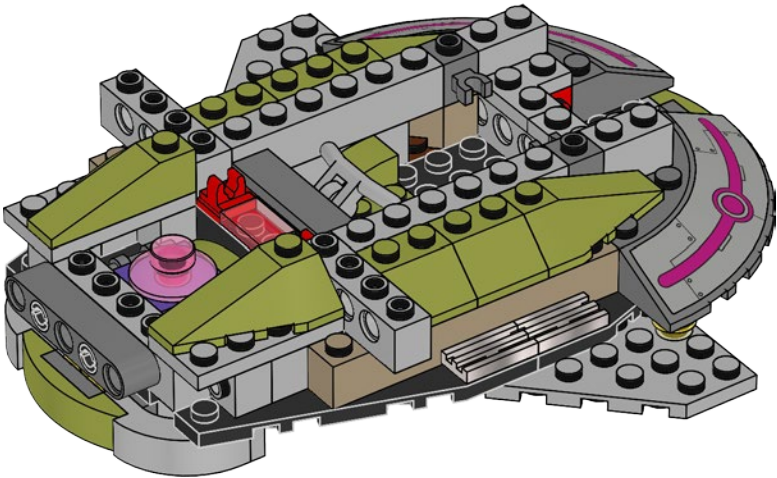

32

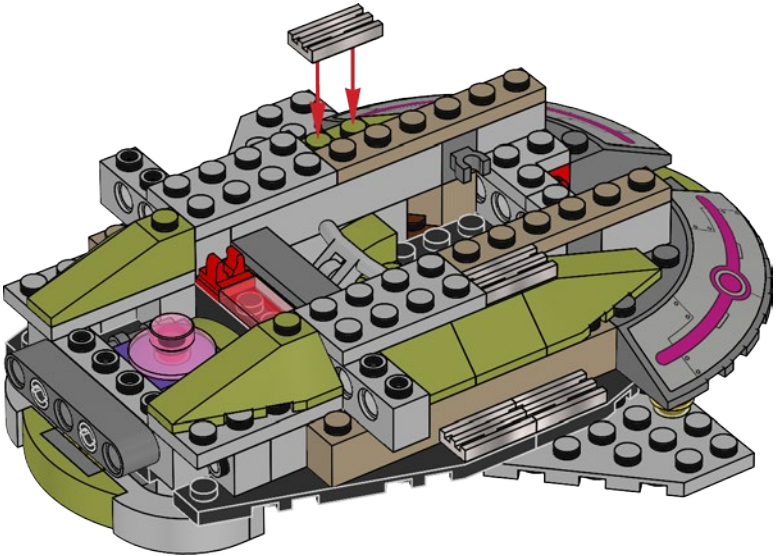

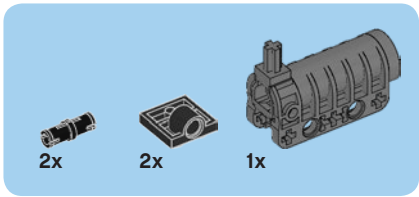

33

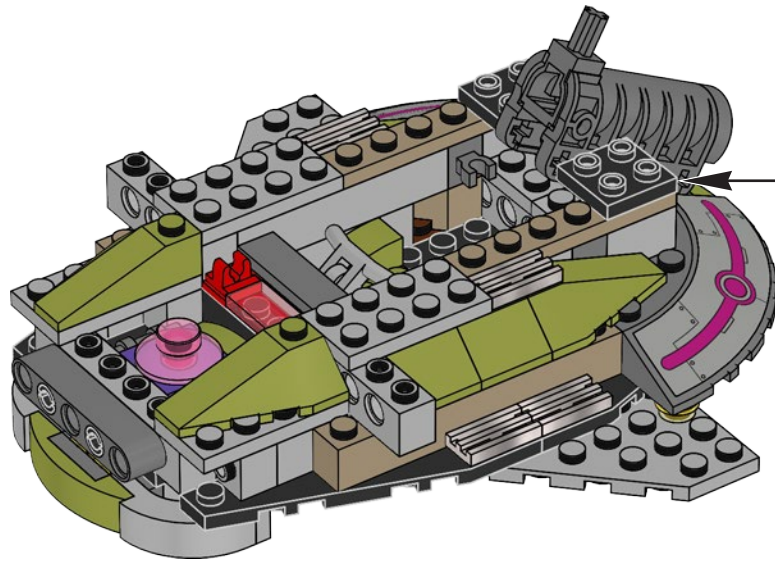
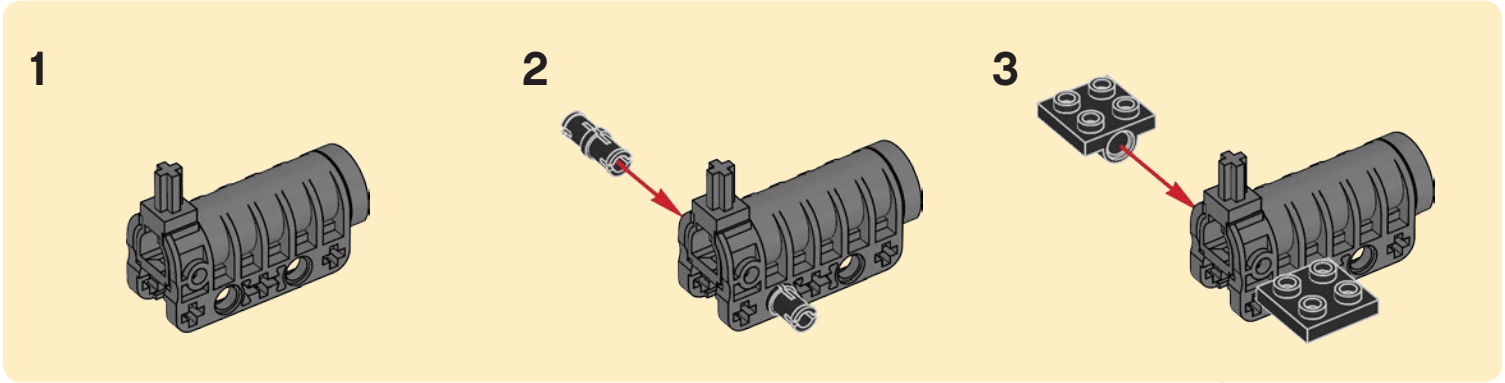

2x

2x

34

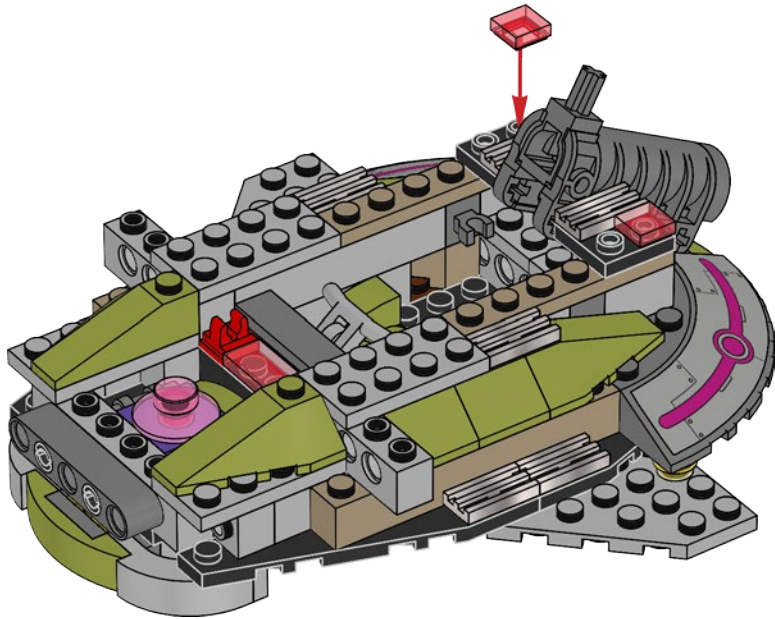

2x

2x

35

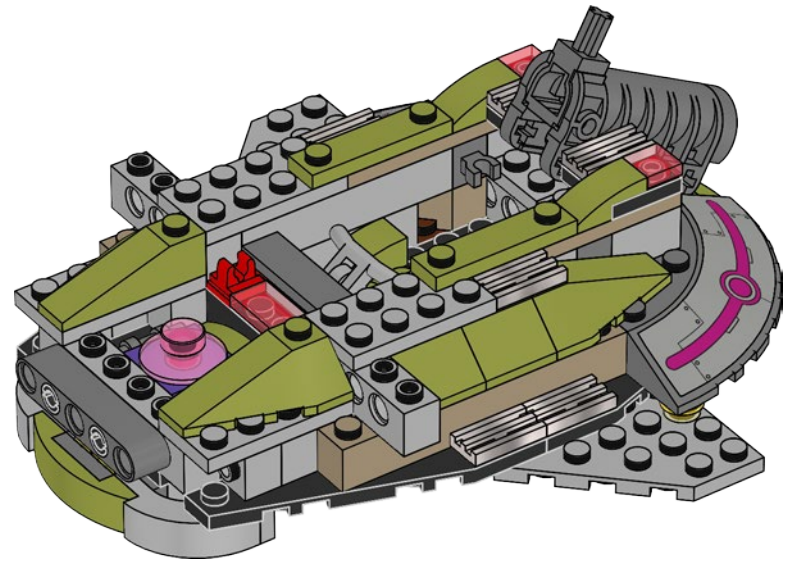



2x



2x

36

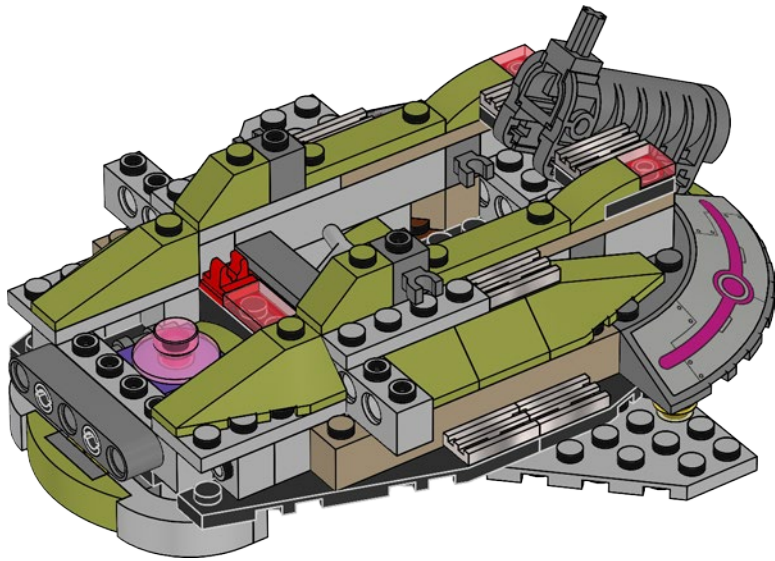

2x



2x

37

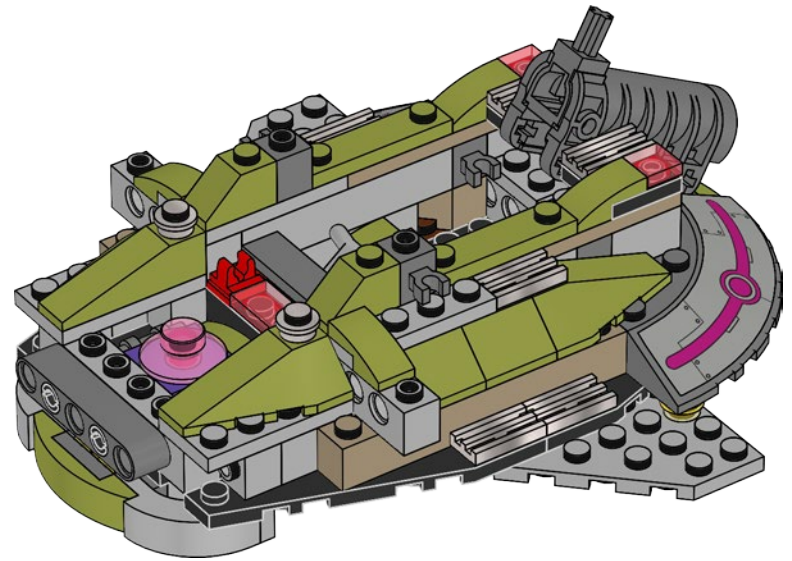



2x

38

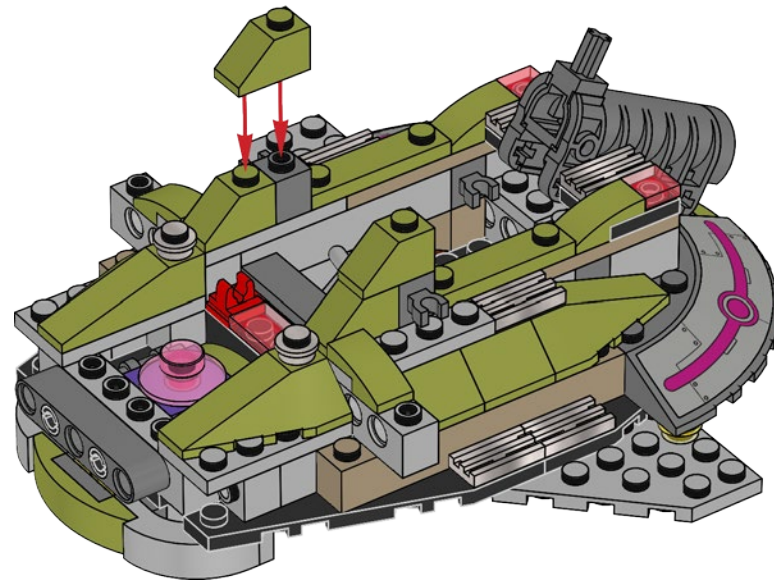

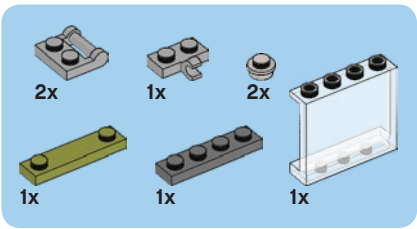

39

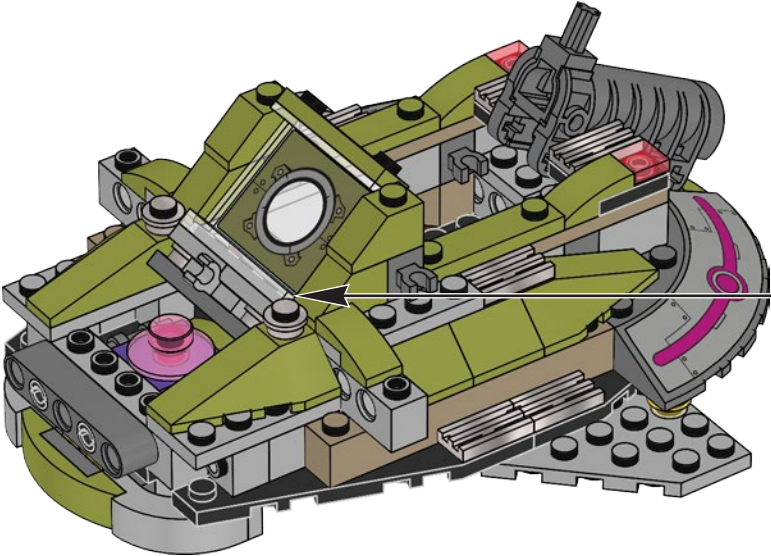
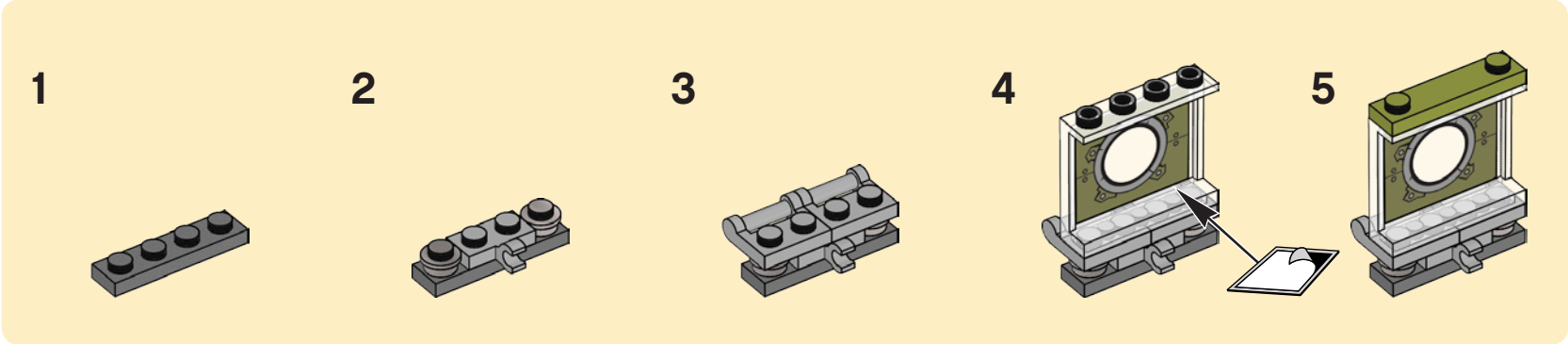

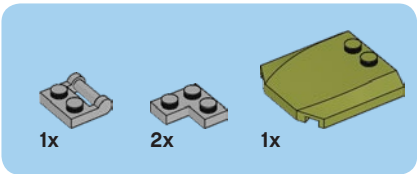

40

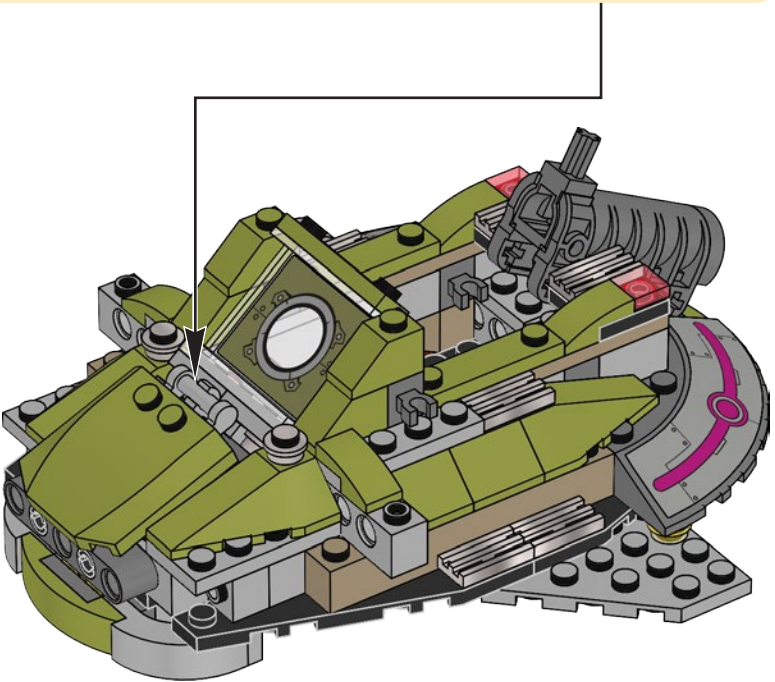
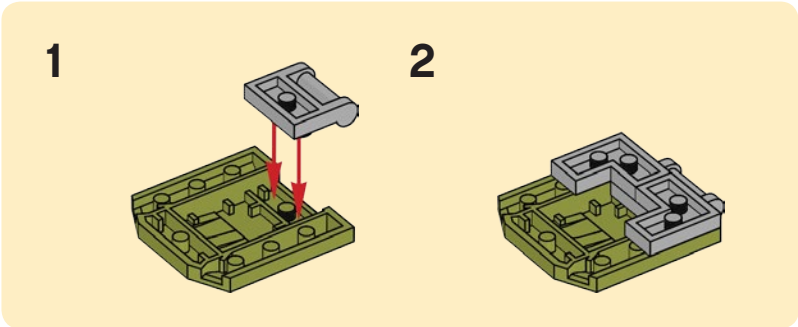



2x

41

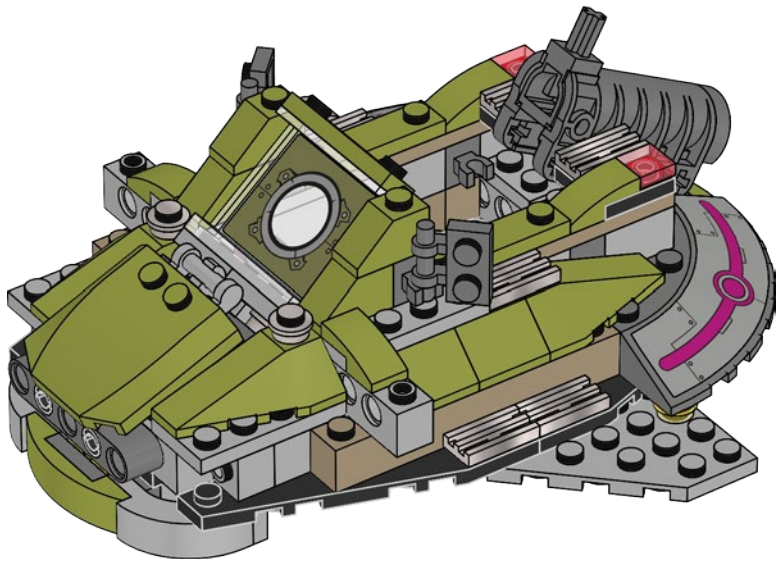

2x



2x



2x

42



1

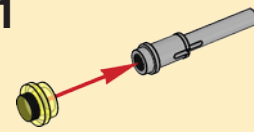

2

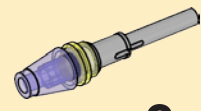

2x

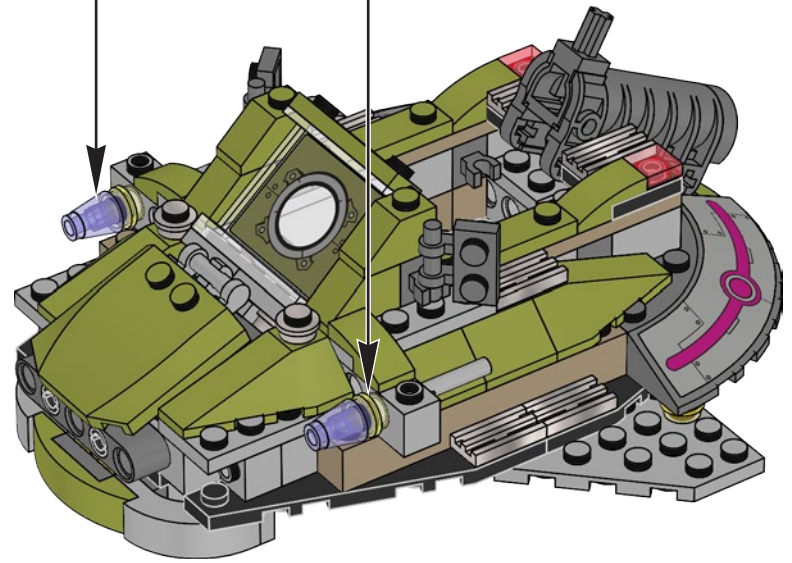



4x

43

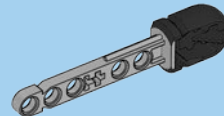
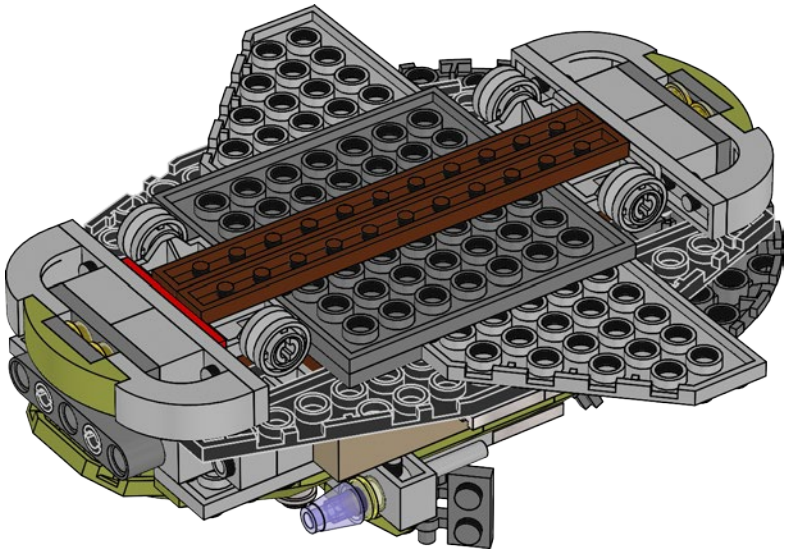

1x

44

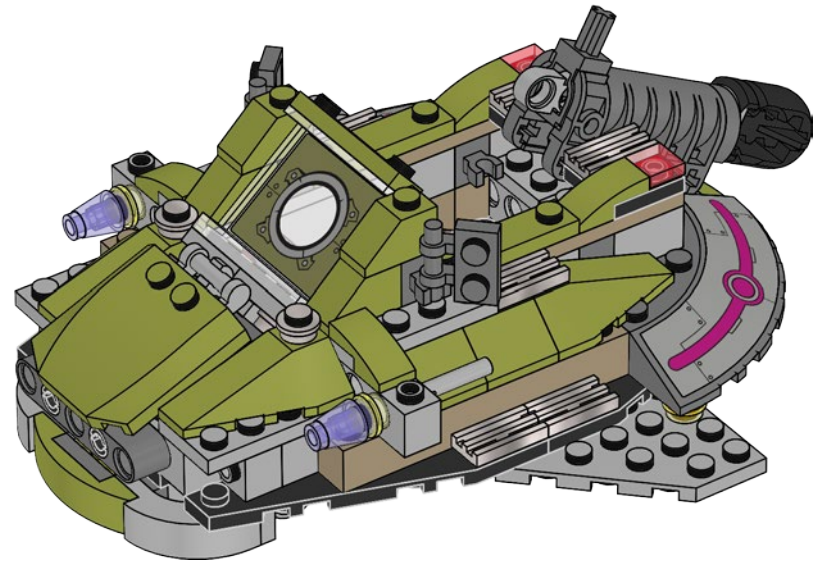

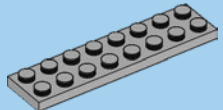
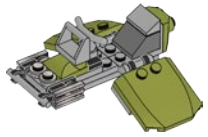

1x

1

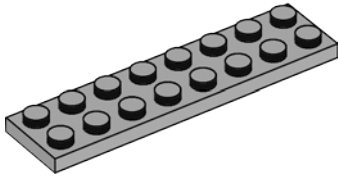

2x



1x

2

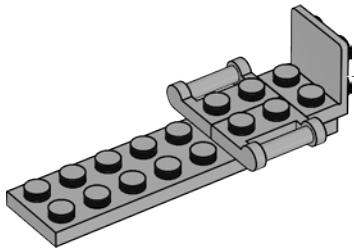
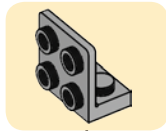

1x



2x

3

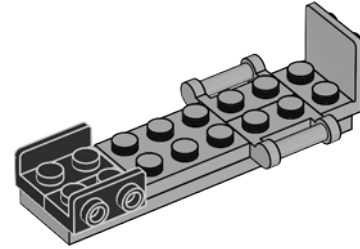

1x

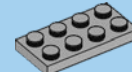

1x

4

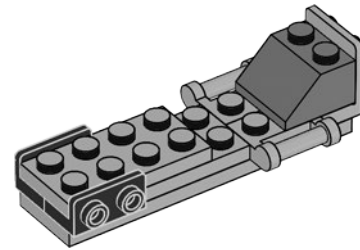



1x

5

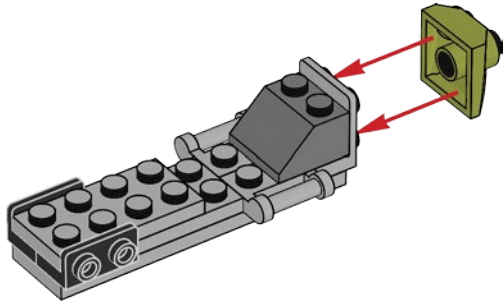

1x



1x

6

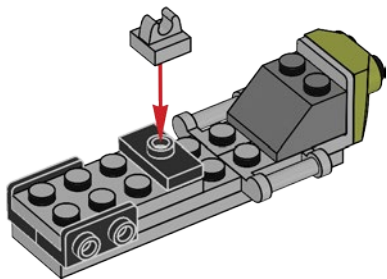

2x



1x

7

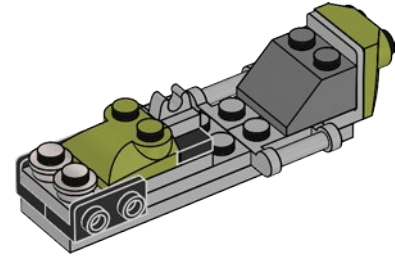

2x

8

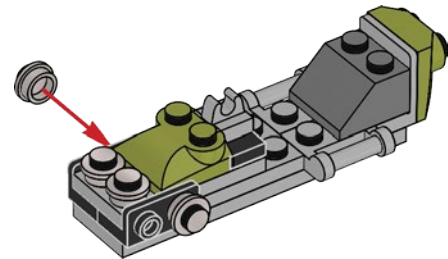



2x

9

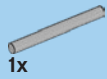
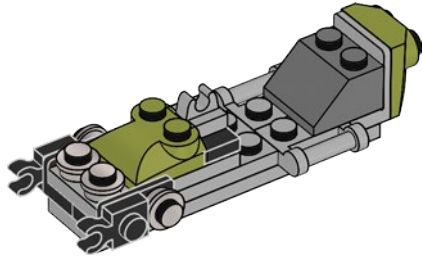

1x



2x

10

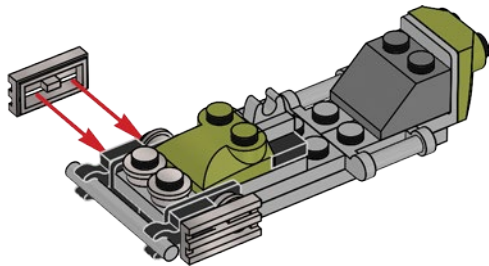

1x

11

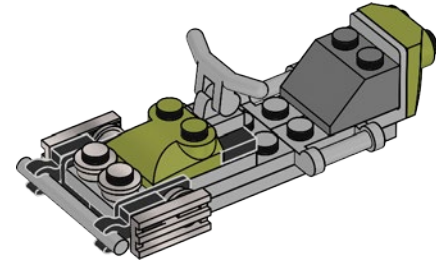

1x



1x

12

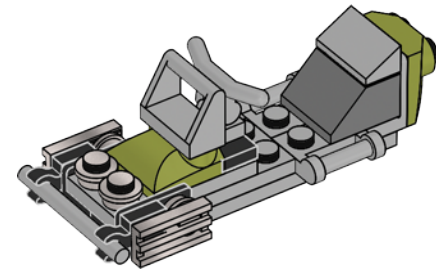

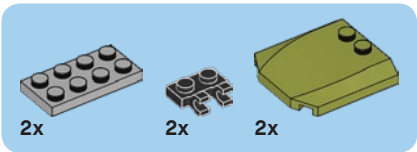

13

